



# **New Active Feedback Scheme for Minimization of Instrumental Asymmetries**

Maya Fabrikant

# Chirality

An object is chiral if it cannot be superimposed onto its mirror image. It comes from the Greek word for hand. Molecules can also be chiral- the most famous is DNA. All you really need for a chiral molecule is 4 different atoms arranged in a tetrahedral structure. Circularly polarized light is chiral. Electrons can also be chiral- if an electron's spin momentum vector is parallel to its velocity vector, we call it right handed. If they are anti-parallel, we call it left handed.

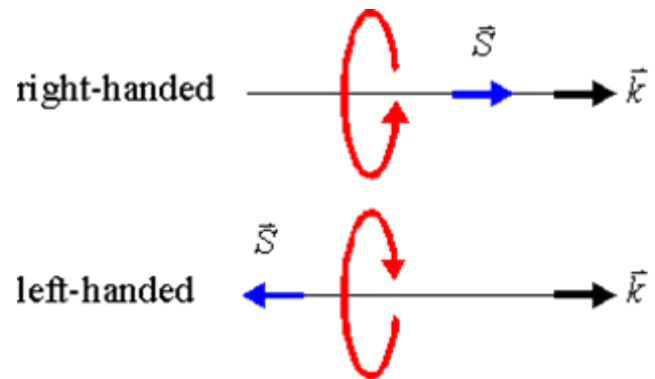
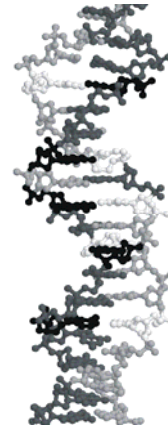
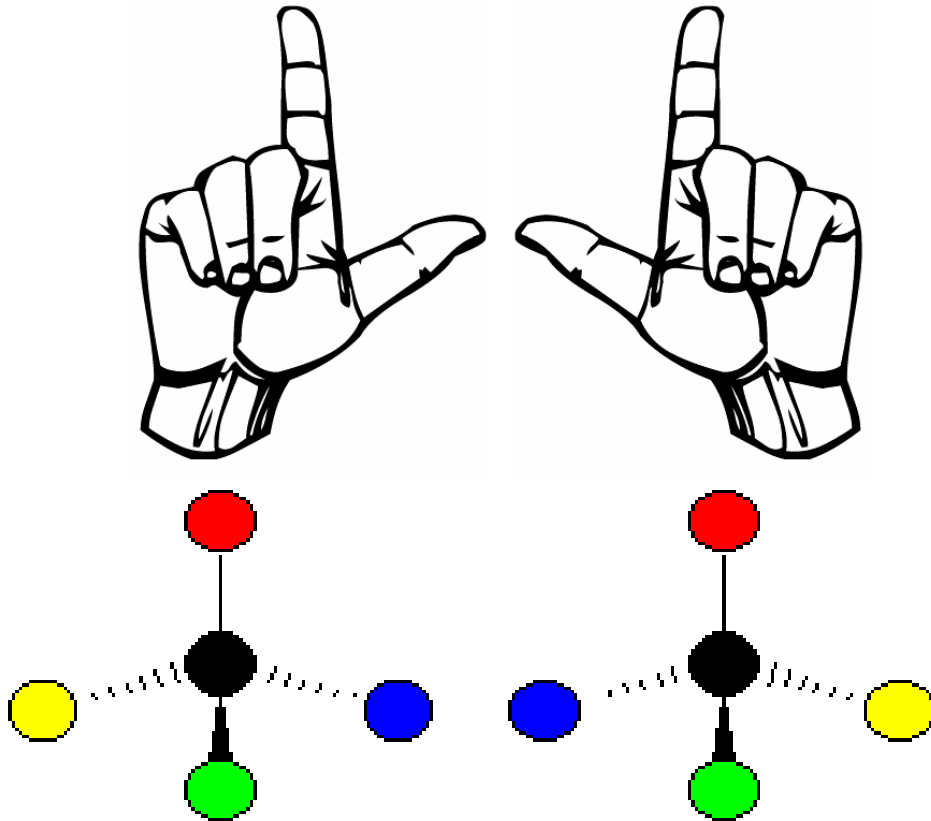

# Circular Dichroism Biot 1805

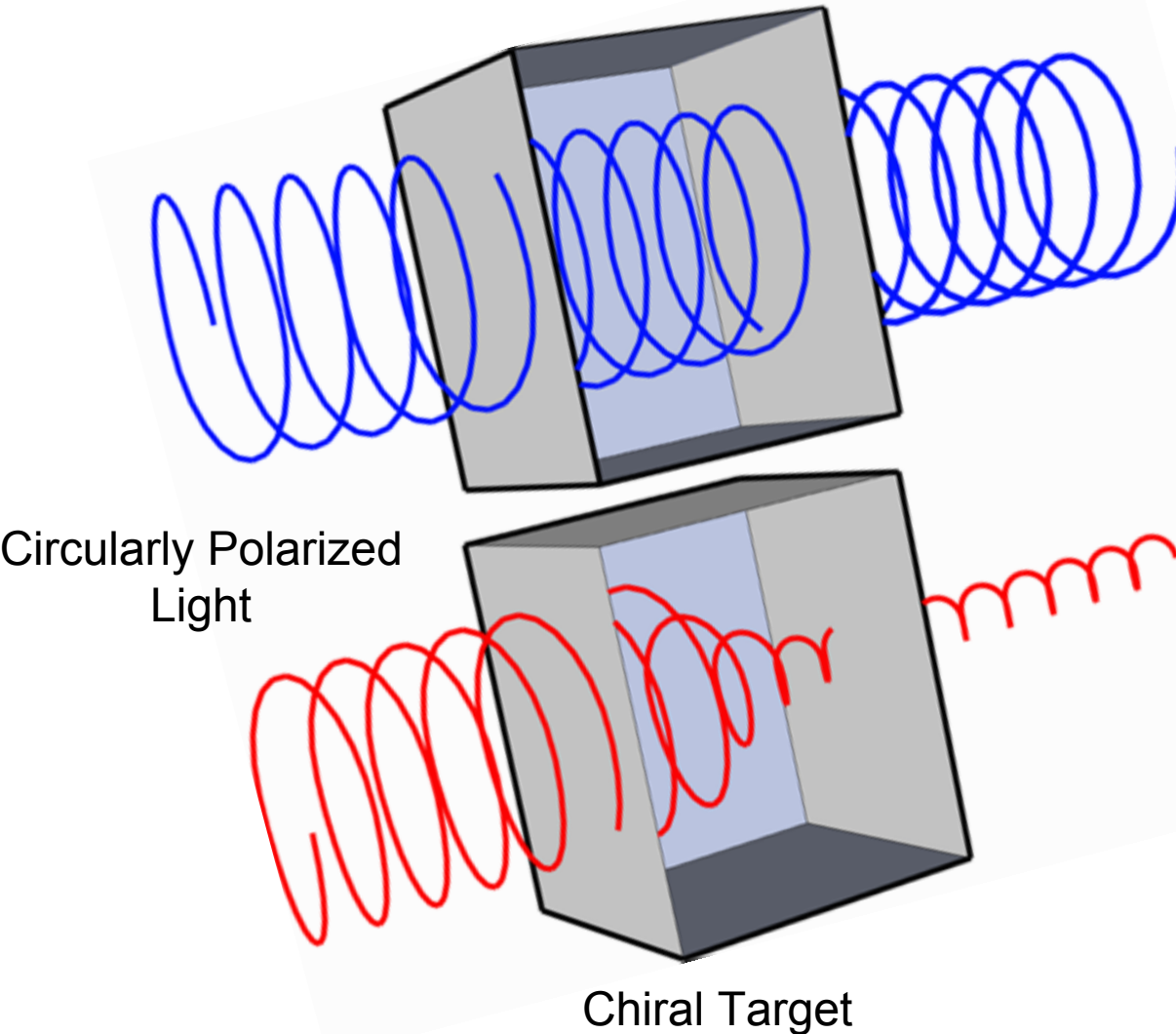

Normally chiral objects and their mirror images act identically. However, when they interact with other chiral objects, interesting effects result. One such effect is circular dichroism. This occurs when circularly polarized light traverses a chiral medium (such as a solution or a gas). One helicity of the light is preferentially absorbed (in the picture on the left, the LCP is absorbed but the RCP is not).

# What About Electron Circular Dichroism?

One could imagine that an effect similar to circular dichroism could occur with electrons. In this case electrons of one helicity (say, forward spin electrons) would be absorbed more in a chiral gas target than the other helicity (backward spin electrons). We show in this slide a cartoon of how this effect could be measured.

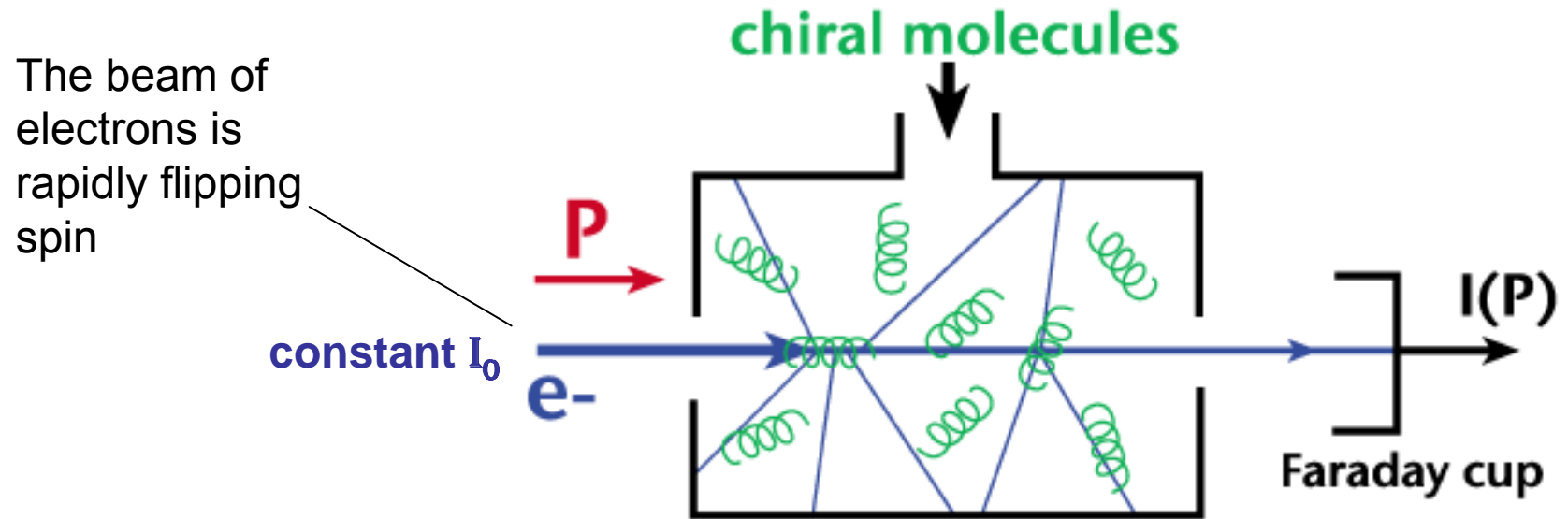

We define a quantity called asymmetry:

$$A = \frac{I_{\text{trans}}^+ - I_{\text{trans}}^-}{I_{\text{trans}}^+ + I_{\text{trans}}^-}$$

Both currents are positive, so  $A$  varies from -1 to 1. If  $A$  is nonzero, then Circular Dichroism is occurring.

# Creation of Polarized Electrons

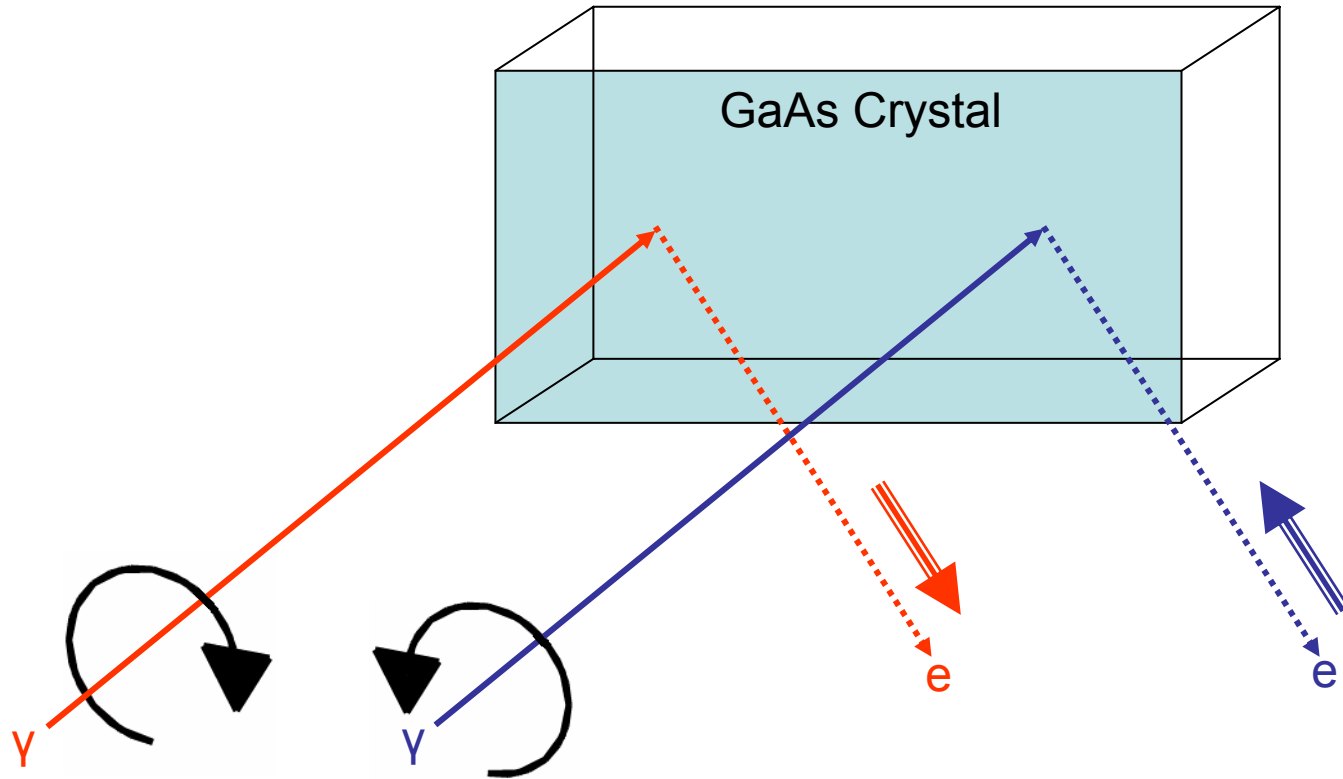

Galium Arsenide is a semiconductor that spews polarized electrons when it is struck with circularly polarized light. It is important to note that the crystal does not have spatially uniform *quantum efficiency* (the number of electrons out per photon in). This causes helicity dependent asymmetries before the electrons even get to the chiral gas, which means that we would see an asymmetry even with Argon (an achiral gas). We call this fake asymmetry instrumental asymmetry.

# Problems

- The Asymmetry we expect to see is very small,  $\sim 10^{-4}$
- As we saw in the previous slide, any helicity-dependent intensity or spatial variation of the light incident on the GaAs will mimic a real experimental asymmetry
- The observed optical instrumental asymmetry is large and exhibits long-term drift

# Helicity Flipping Scheme

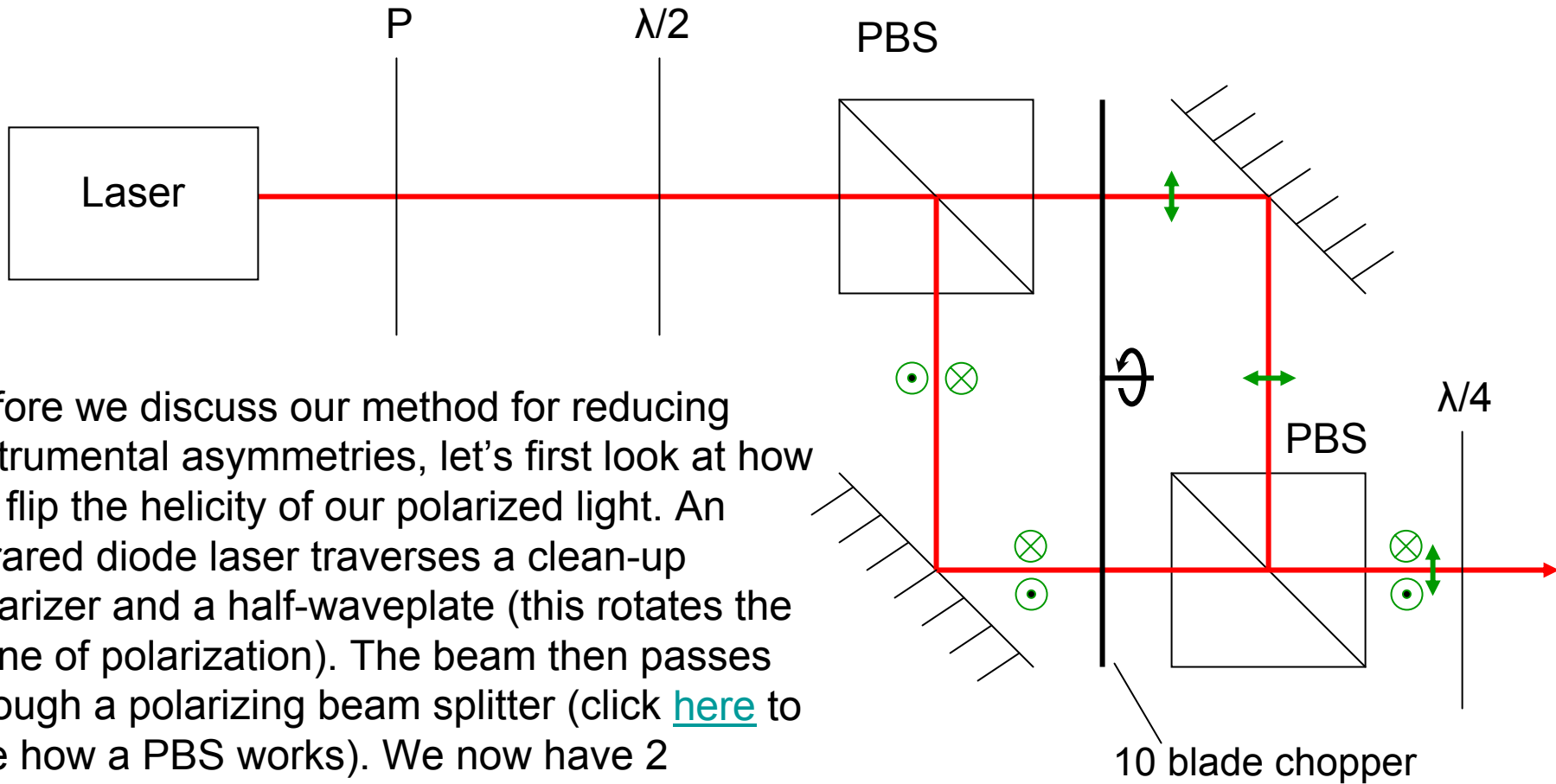

Before we discuss our method for reducing Instrumental asymmetries, let's first look at how we flip the helicity of our polarized light. An Infrared diode laser traverses a clean-up polarizer and a half-waveplate (this rotates the plane of polarization). The beam then passes through a polarizing beam splitter (click [here](#) to see how a PBS works). We now have 2 orthogonally polarized beams, which would be recombined at the second beam splitter, except that we pick out one beam at a time with a chopper. The beams are then converted to circularly polarized light with a quarter-waveplate

# Measuring Optical Asymmetry

after the beams leave the optical system they are read with a computer. We use the trigger signal to tell us the helicity of the red signal. A computer program bins the red signal into its respective helicities, averages the values, and computes an asymmetry. We repeat this procedure 1000 times to make one asymmetry measurement complete with error bar.

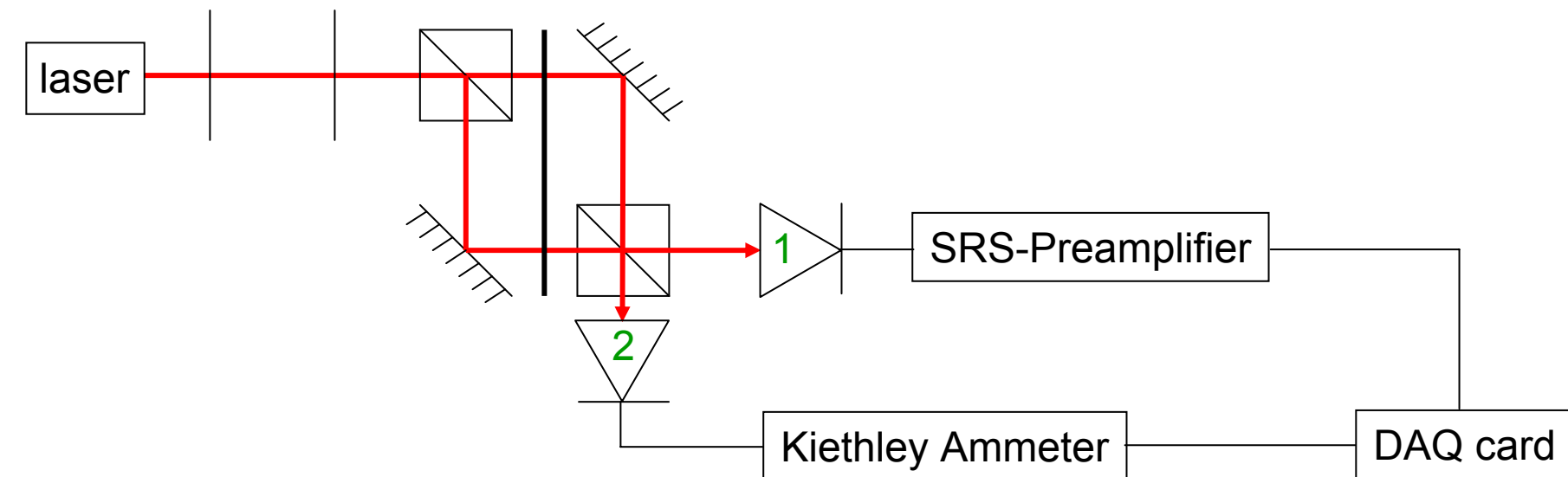

— Trigger signal (diode 2)

— Signal for which A is computed (diode 1)

sample rate = 200 kHz  
chopping rate = 500 Hz

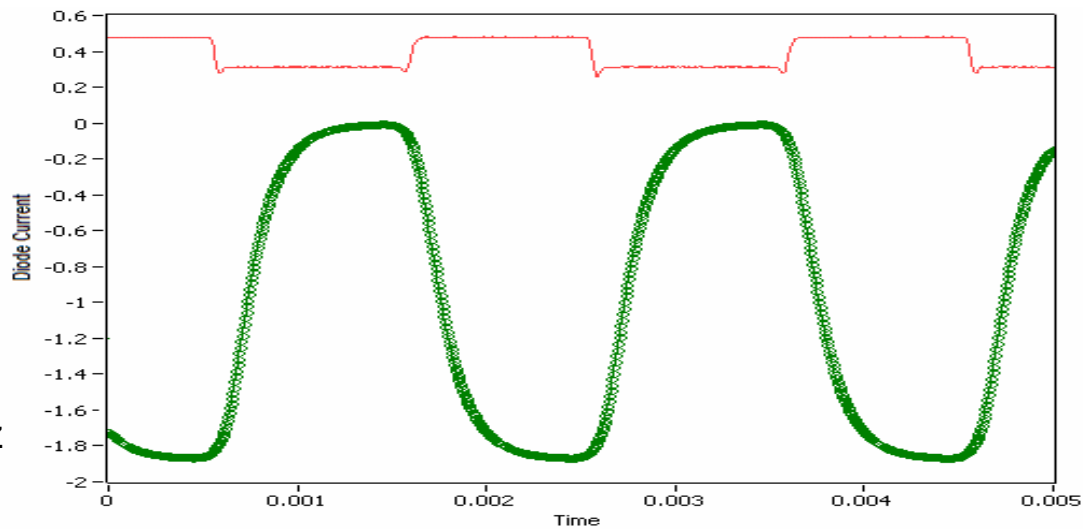



# Why Flip Helicity?

Why not just measure the transmission of one helicity for a long time, switch, and take data again? The answer is that the intensity of the signals drifts with time, so it makes more sense to take many precise asymmetry measurements quickly, before the intensity has time to drift.

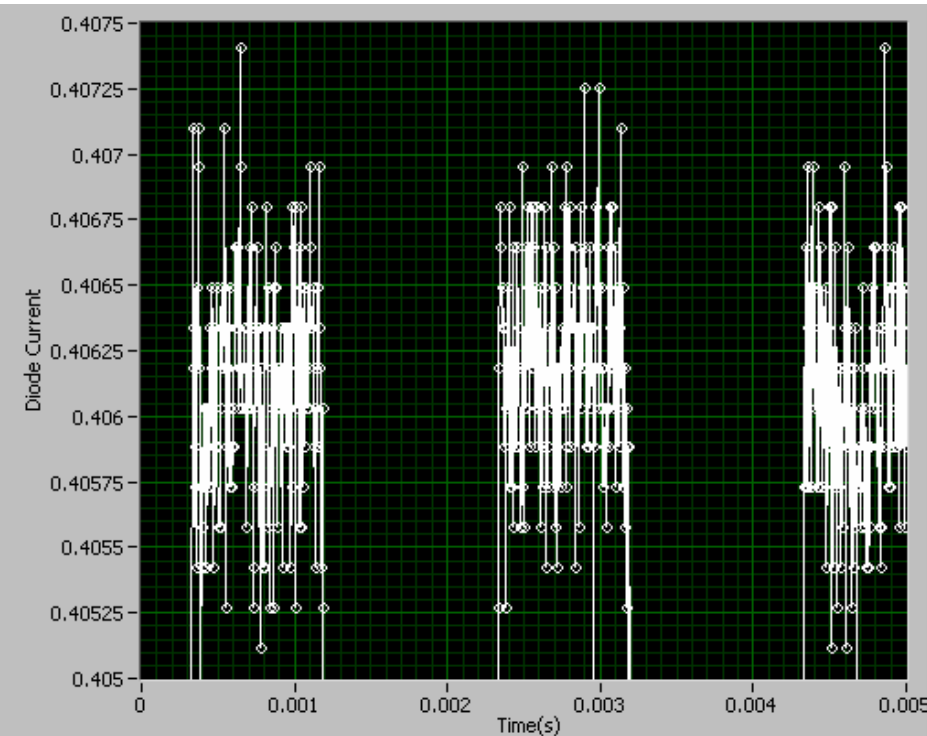
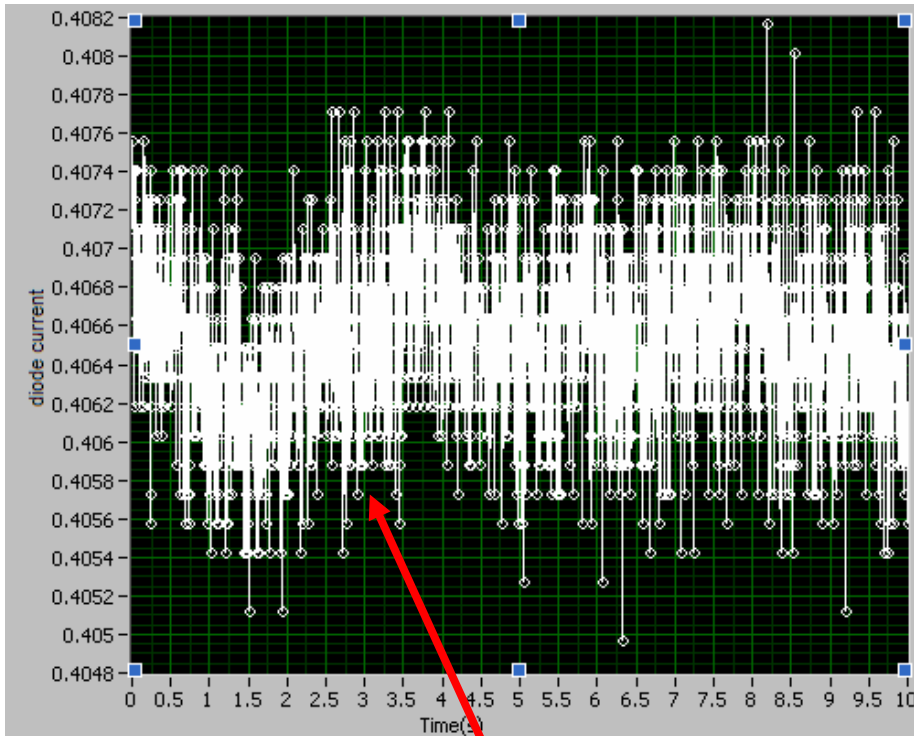

Intensity drifts  
with time

To emphasize the importance of helicity flipping: If the asymmetry drifts in time, to resolve the asymmetry drift we must sample the asymmetry quickly.

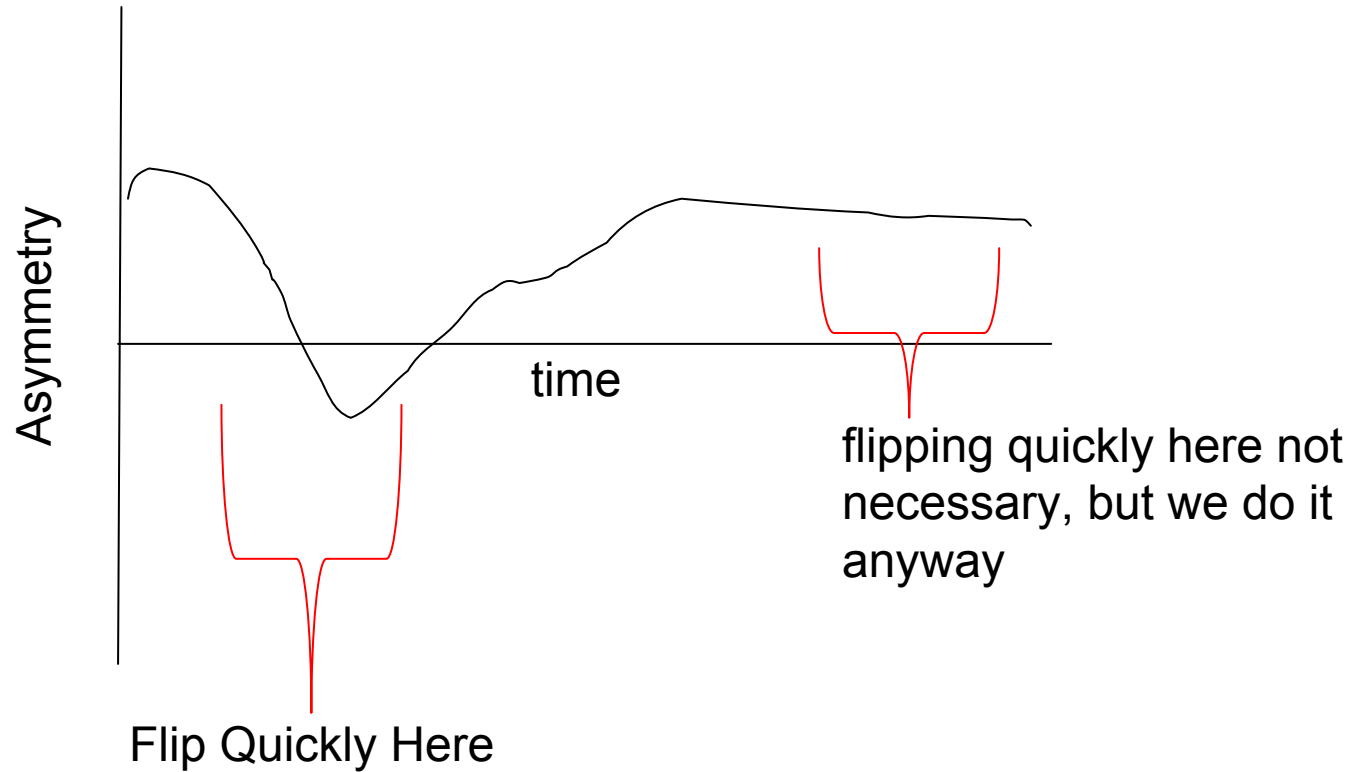

# Consequences of Flipping

Physical imperfections in the chopper blades cause intensity spikes when we flip helicities. These spikes will cause problems later on.

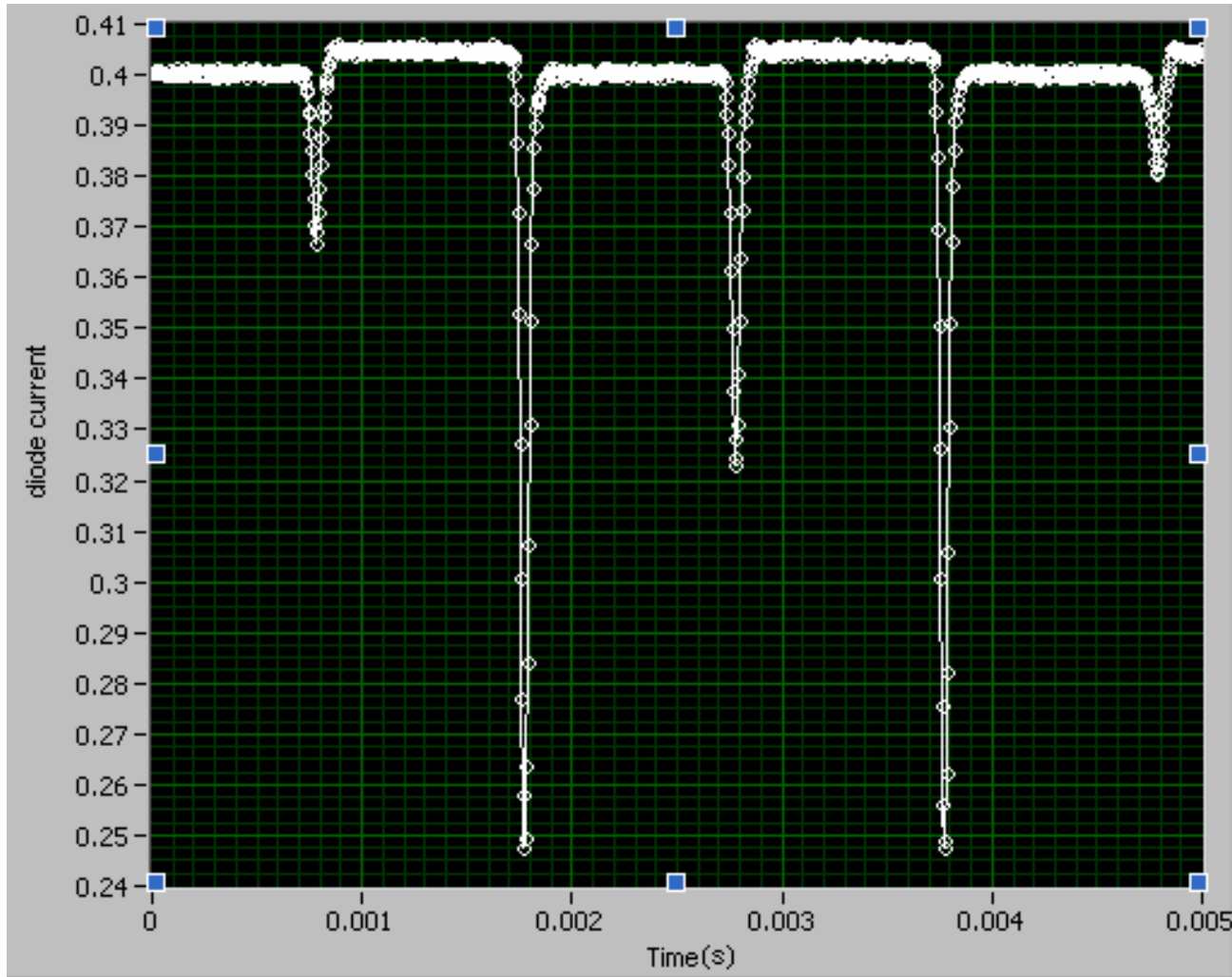

# Controlling Asymmetry with the Half Waveplate

We can rotate the half-waveplate to rotate the plane of polarization of the beam incident on the first beam splitter. This “redistributes” the intensity amongst the two beams. In the cartoon below there is too much light in the blue beam and not enough in the red. We can rotate the half waveplate by an angle  $\Theta$  to redistribute this. However, we calculated that the asymmetry varies like  $A = \sin 4\Theta$ . If we wish to maintain the asymmetry to a precision of  $10^{-5}$ , the precision in  $\Theta$  must be better than .5 arcsec. This is at the limit of what today’s nanorotators can achieve.

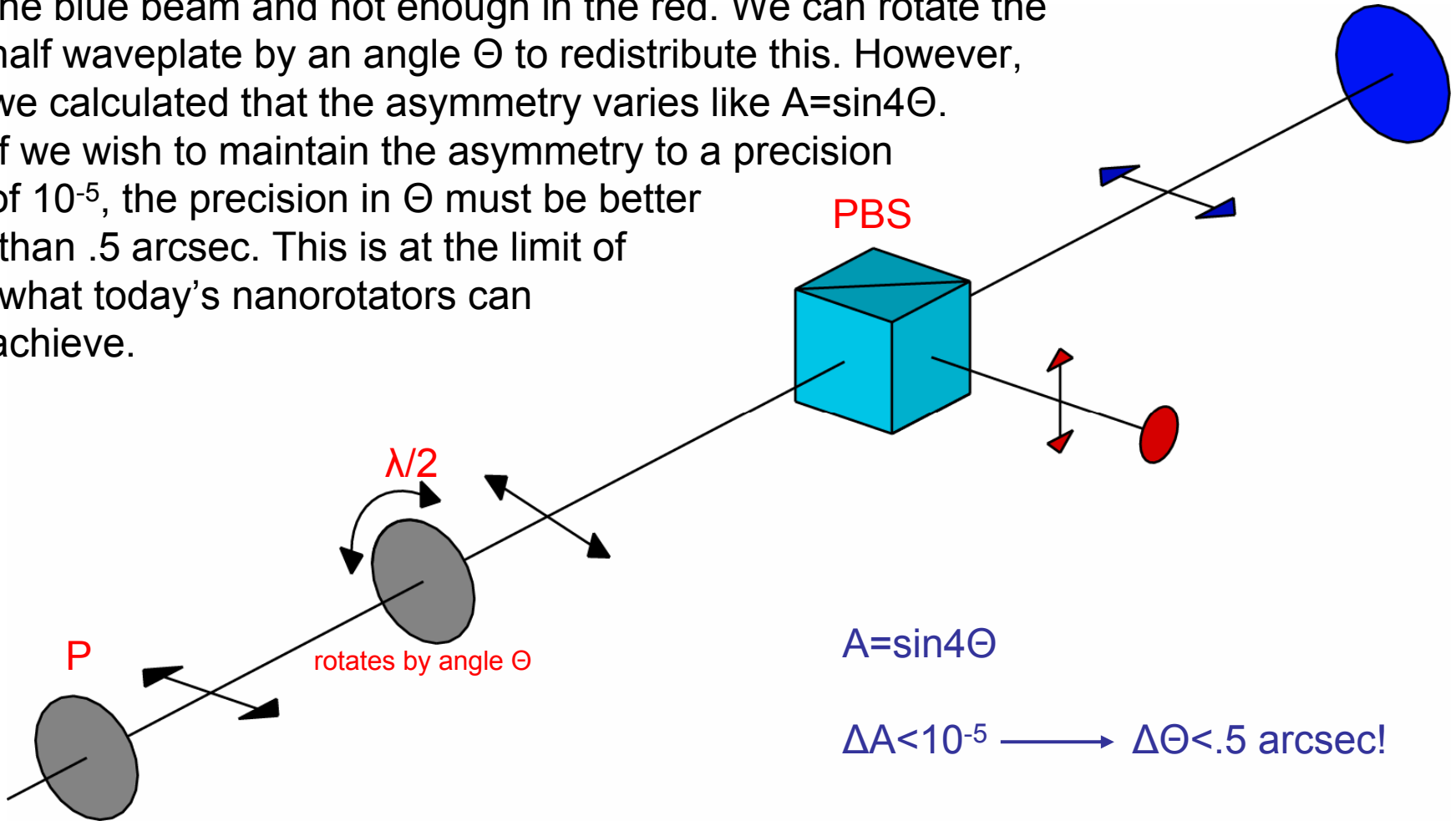

retardance may be controlled by a voltage

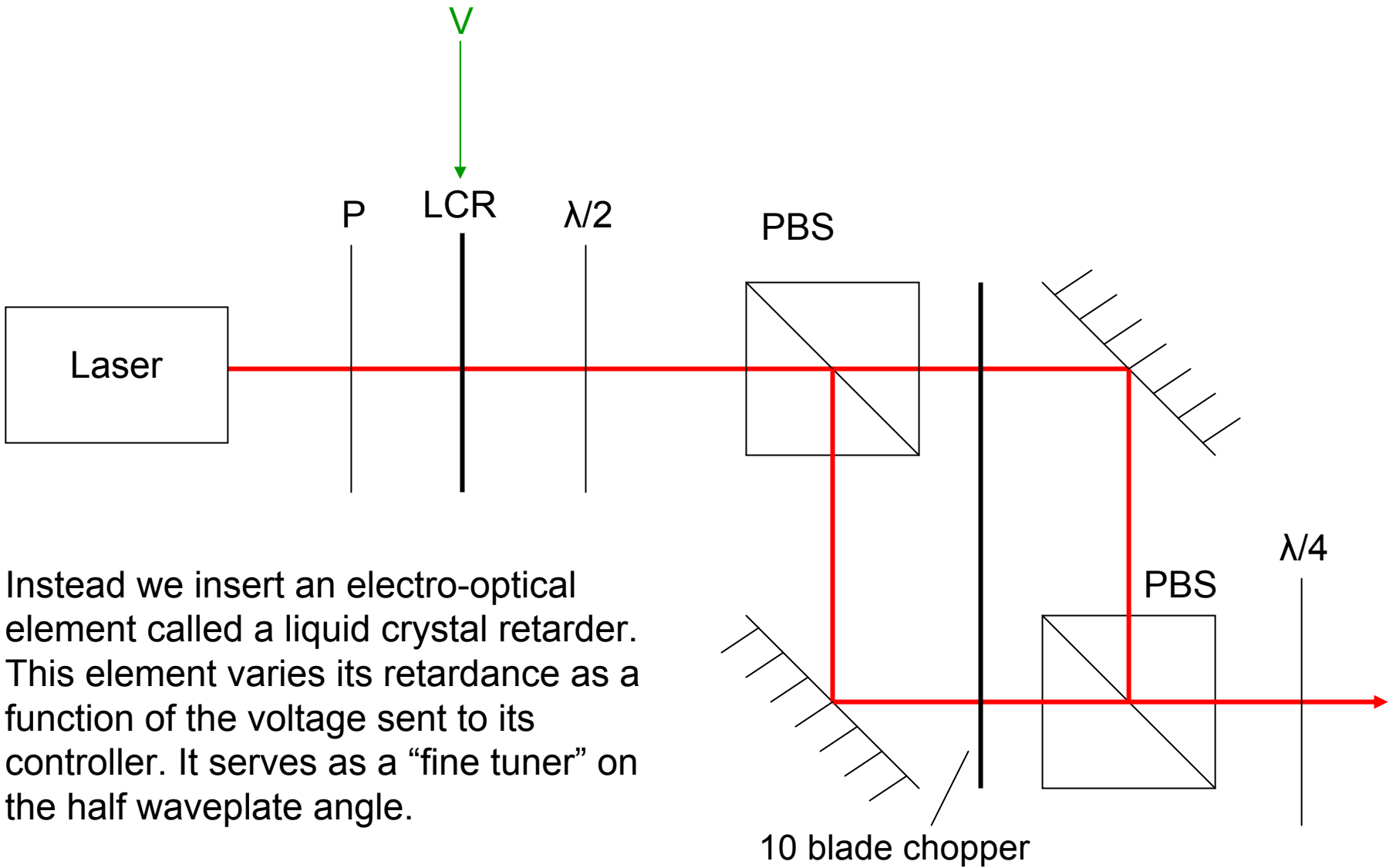

Instead we insert an electro-optical element called a liquid crystal retarder. This element varies its retardance as a function of the voltage sent to its controller. It serves as a “fine tuner” on the half waveplate angle.

A pretty picture of the retarder and its Retardance vs voltage function (provided by meadowlark optics). Note the reflection of the researcher's digital camera. Classy.

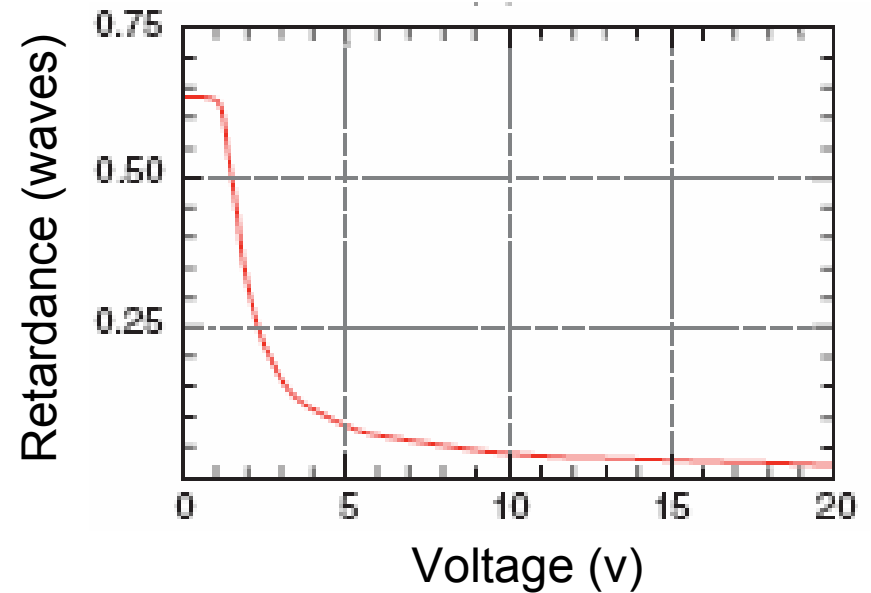

Standard proportional feedback is performed according to the following algorithm:

$$V_{t+1} = v_0 A + V_t$$

Voltage output (points to  $V_{t+1}$ )  
some constant (points to  $v_0$ )  
measured asymmetry (points to  $A$ )  
Voltage output during the previous iteration (points to  $V_t$ )

We find the unknown constant by ramping the voltage to the LCR and measuring the asymmetry at each voltage. We then take a linear approximation and solve for the constant:

$$A_l(v) = A_0 + \frac{dA}{dv} v_0$$

$$A_l = 0 \longrightarrow v_0 = \frac{-1}{\frac{dA}{dv}}$$

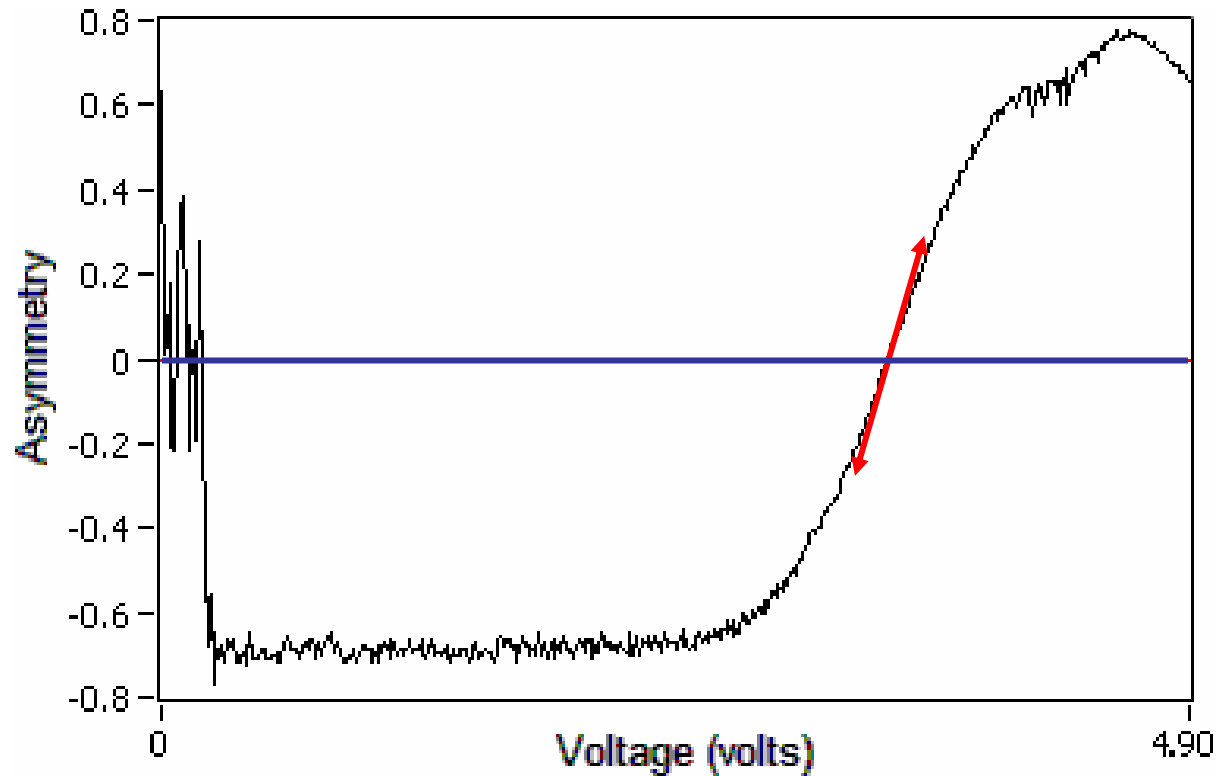

# Short Term Results

The asymmetry is forced to zero within a few iterations. The only problem is it took awhile.

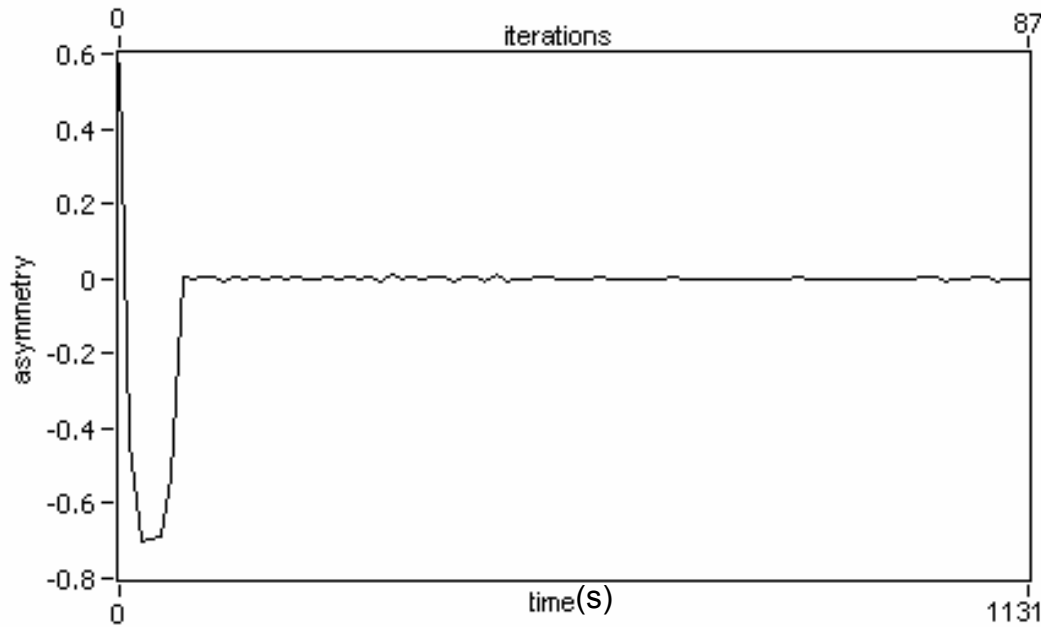

We wanted to see how resilient the scheme was. The system is very sensitive to mechanical vibrations, so we forced the asymmetry to zero and whacked the experiment with a hammer. The asymmetry goes back to zero in a few iterations.

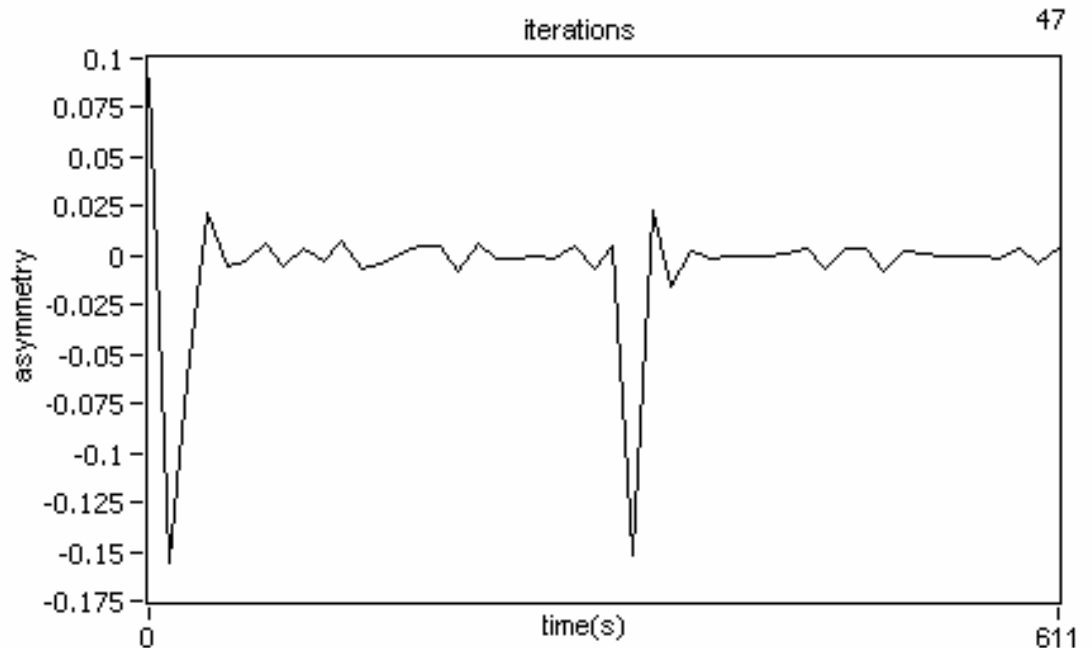



# Long Term Results

We keep our asymmetry at 0 for about the length of a data taking cycle. The graphic says it all, really.

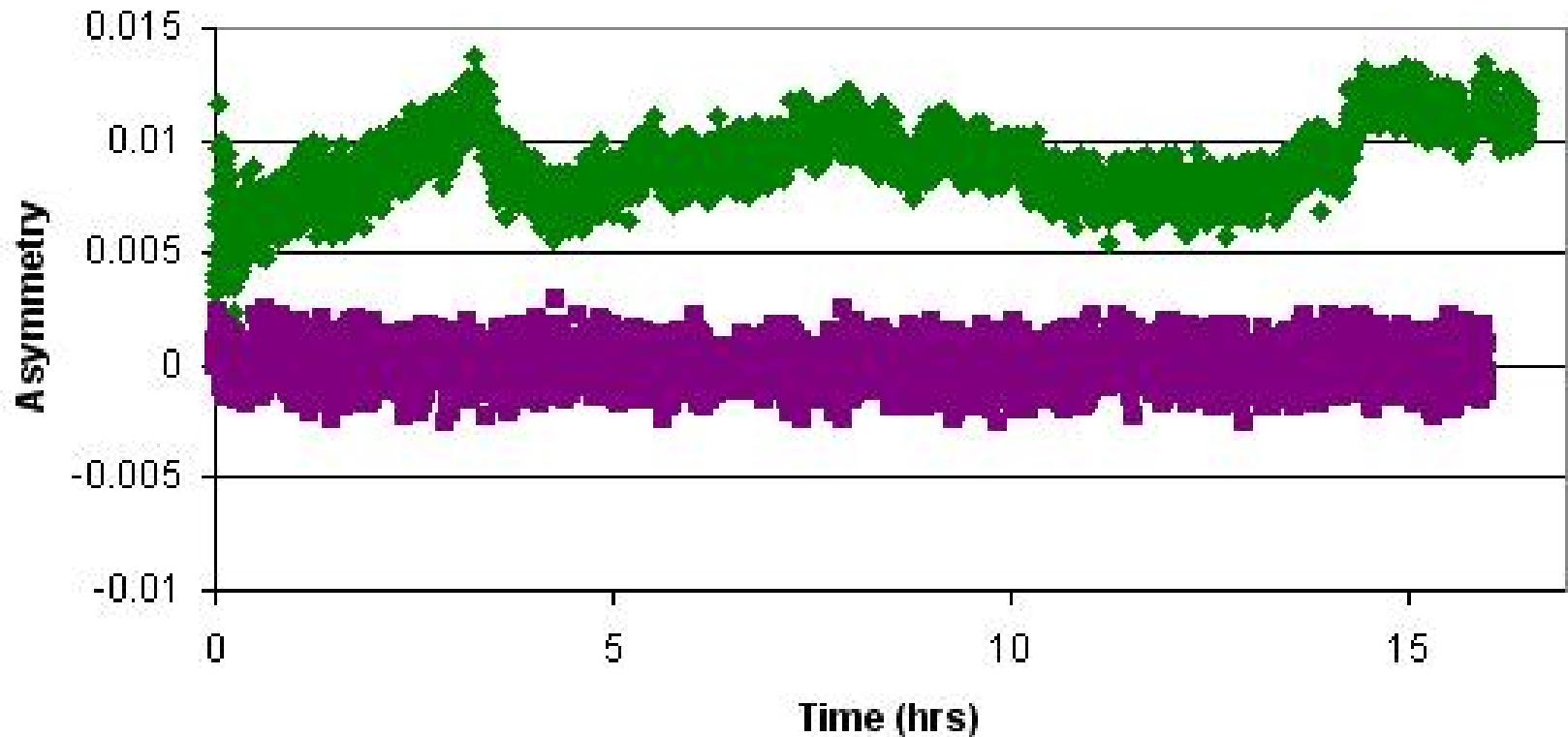

without feedback Average  $\sim 7 \times 10^{-3}$

with feedback Average  $A = -1.5(3) \times 10^{-5}$

Lock In Amplifier Technique- the only problem with the previous technique is that it was too slow, so we use a lock-in amplifier instead (click [here](#) if you don't remember how lock-in amplifiers work).

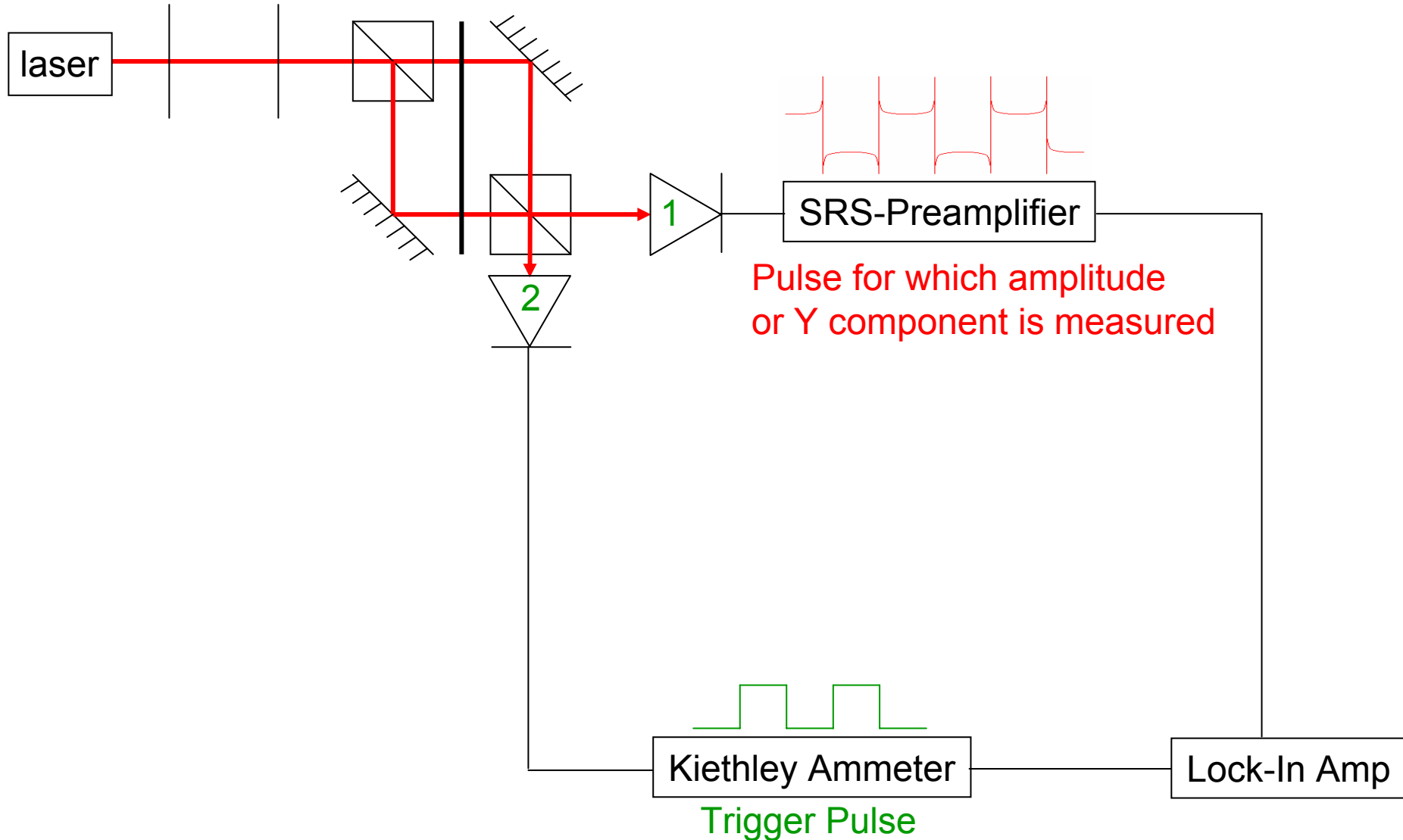

Why is a lock-in useful for minimizing asymmetry? If you recall the formula for Asymmetry, you can see that it is proportional to the amplitude of the signal, which is also the amplitude coefficient of the first harmonic of the Fourier series (the R from the lock-in output). Feeding back on something proportional to A is just as good as feeding back on A.

$$A = \frac{I^+ - I^-}{I^+ + I^-} \propto \text{Amplitude}$$

The only problem is that the spikes we mentioned earlier have components in the Fourier series and contribute to the amplitude.

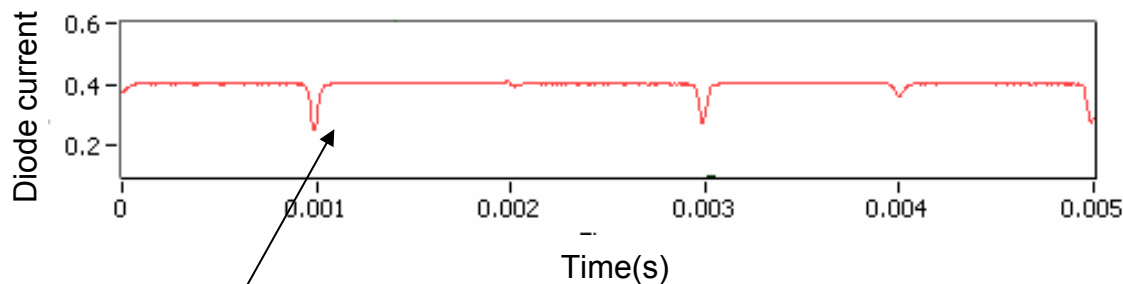

R is never 0!

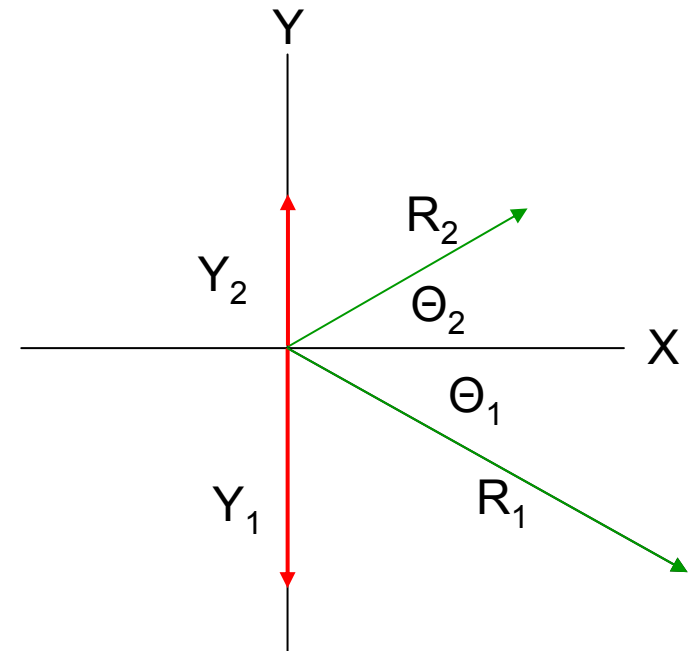

However, if  $\Theta$  is held constant, flipping Y constitutes a flip in R, which also flips Asymmetry. We therefore feed back on Y.

# Results

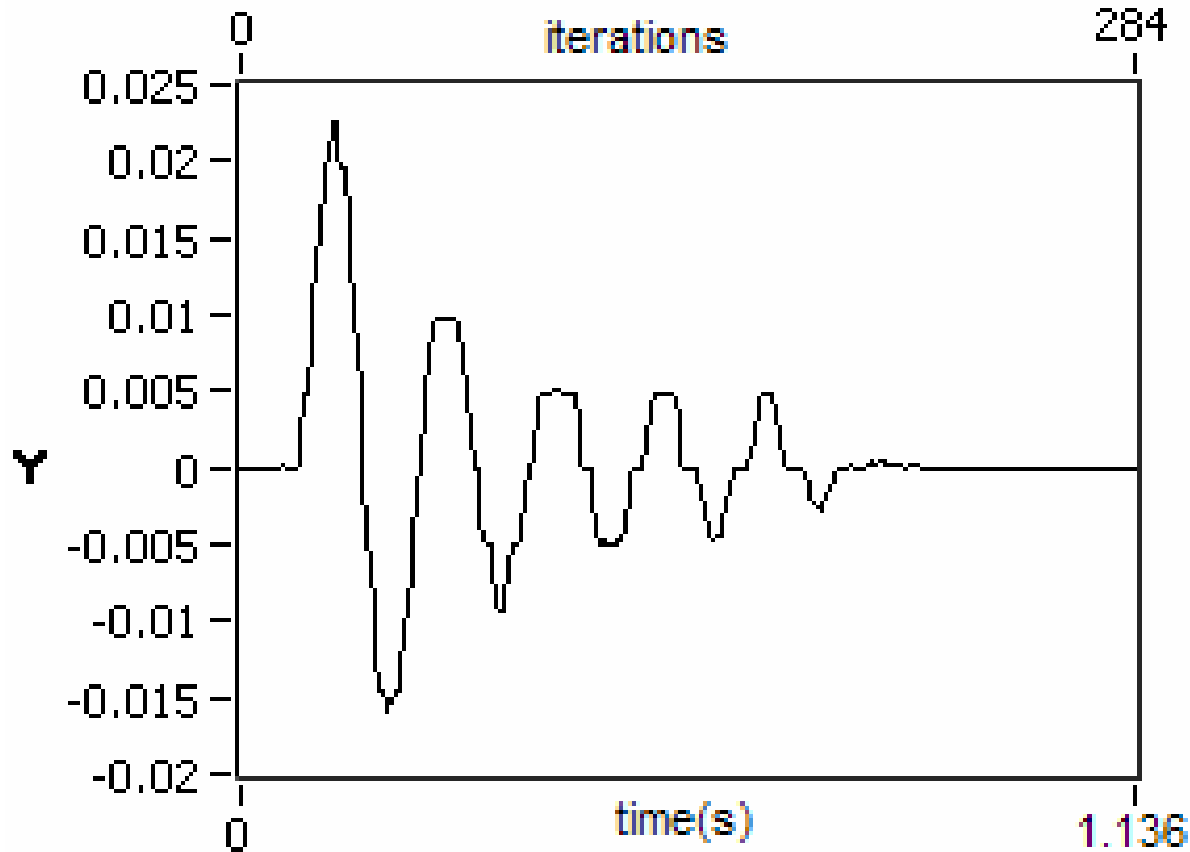

The results are pretty good. Although it takes many more iterations of the algorithm before the asymmetry is set to 0, the speed of the algorithm is such that we are able to do this almost 1000 times faster.

# Conclusions and Further Research

- We have achieved control on optical instrumental asymmetries an order of magnitude better than anticipated true signal
- We still need to Implement PID control to try to eliminate cycling, to investigate long-term lock in behavior, and finally to use feedback to control current from GaAs crystal and perform the original experiment.

If there is anything you don't understand or are angry about, send an e-mail to

[IfAyam@gmail.com](mailto:IfAyam@gmail.com)